

Diavolino



An open-source hardware+software project. For design files and additional documentation, please visit: <http://www.evilmadscientist.com/go/diavolino>

Support: <http://www.evilmadscientist.com/forum/>

Distributed by
Evil Mad Science LLC
<http://evilmadscience.com/>



Kit version 1.0
Manual v. 1.0a

Diavolino

Bill of materials (for basic kit)

Kit contents:

Line	Description	Value	Digi-Key Equiv.	Qty
1	PCB	Diavolino circuit board	n/a	1
2	Quick-start card		n/a	1
3	Resistor, 1/4W	1k	1.0QBK-ND	1
4	Resistor, 1/6W	10k	10KEBK-ND	1
5	Capacitors	18 pF (marked w/ black stripe in kits)	BC1004CT-ND	2
6	Capacitors	0.1 uF	BC1148CT-ND	3
7	Tactile button switch	Two pin	CKN9102-ND	1
8	LED, 3 mm	Red diffused	P606-ND	1
9	Crystal	16 MHz	631-1108-ND	1
10	Header	6-position Right-angle SIL	22-28-8062	1
11	Microcontroller	ATmega328P-PU	ATMEGA328P-PU-ND	1
12	Wire Jumpers	Zerohm, 1/4W form factor	0.0QTR-ND	3

Diavolino

Identifying the parts

#2: Quick start card

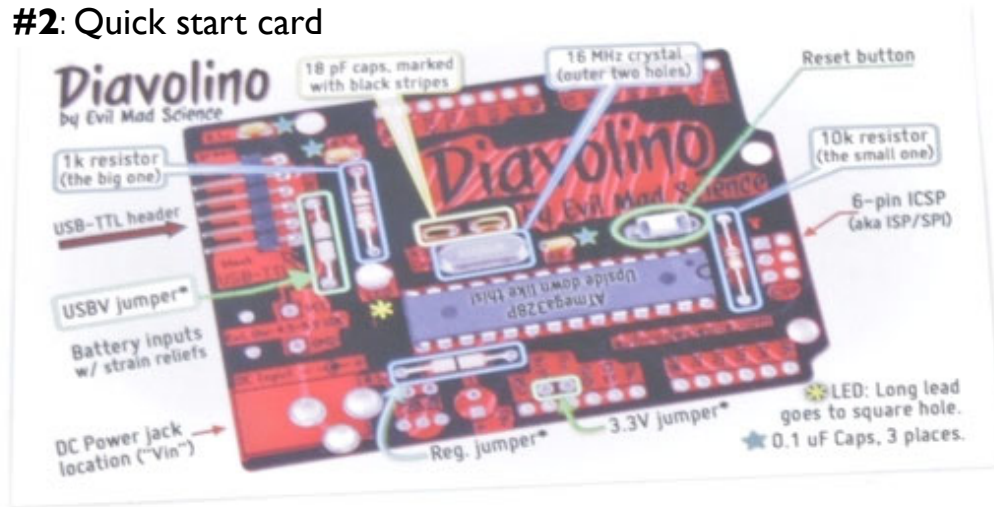

#1: Printed circuit board

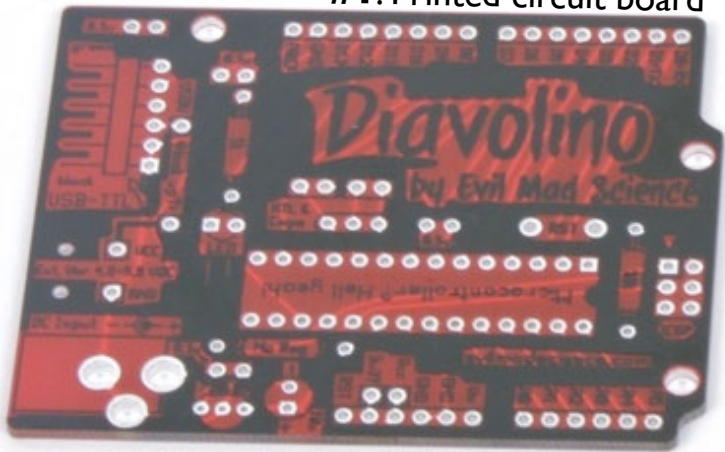

#6: 1 uF caps (3)



#9: Crystal

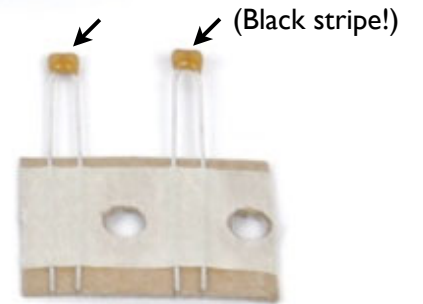

#5: 18 pF caps (2)

#11: Microcontroller



#7: Button switch



#10: Header

#3: 1/4 W, 1 k resistor



#8: LED



#4: 1/6 W, 10 k resistor



#12: Wire jumpers (3)



Diavolino Tool Checklist

Essential tools: Needed to build the kit:



1. Soldering iron + solder

A basic soldering iron meant for electronics, with a reasonably fine point tip. We recommend one of this design-- a "pencil shape" soldering iron (not gun!) with a base that holds the iron and a wet sponge. A tip in good condition (a "tinned" tip) should get shiny when hot-- able to melt and wet to solder.

While you don't need an *expensive* one, the iron *can* make a big difference in the time needed to build the kit. (Seriously. If you use one that is old and busted, or a \$10 radio shack iron, or that thing from the dollar store, please expect to spend at least twice as long soldering!)

Our recommendation for a low-cost iron: model WLC100 by Weller, about \$40.

You'll also need some solder. Thin rosin-core solder (roughly .020 - .040" in diameter) is the most common and best choice for this application. Either standard (lead-bearing) or newer "lead free" solder types will both work just fine.



2. Angle flush cutters

For clipping loose wire ends close to the circuit board.

e.g., Sears Craftsman

Optional but suggested:

1. Resistor lead forming tool

Allows fast, neat bending of resistor leads.



2. Wire strippers



If you're building your kit to run off of batteries, we recommend trimming the leads, for which you'll need to re-strip the ends.

This model is our favorite: Ideal T-Stripper #45-121 (the 14-24 gauge size).

And for Programming...

Diavolino is an Arduino compatible, but requires a programming interface.

1. USB-TTL Cable



FTDI model TTL-232R or equivalent. A "smart" converter cable with a USB interface chip inside. One end hooks up to your USB port, the other to Diavolino. This allows you to program Diavolino through the Arduino development environment (<http://arduino.cc/>).

Alternately, Diavolino can be programmed through an AVR ISP programmer, like the USBtinyISP.

2. Computer, Internet access, USB port....

All of the software that you'll need is available online for free. You'll need a reasonably recent vintage computer (Mac, Windows, or Linux) and internet access to download that Arduino software.

Diavolino

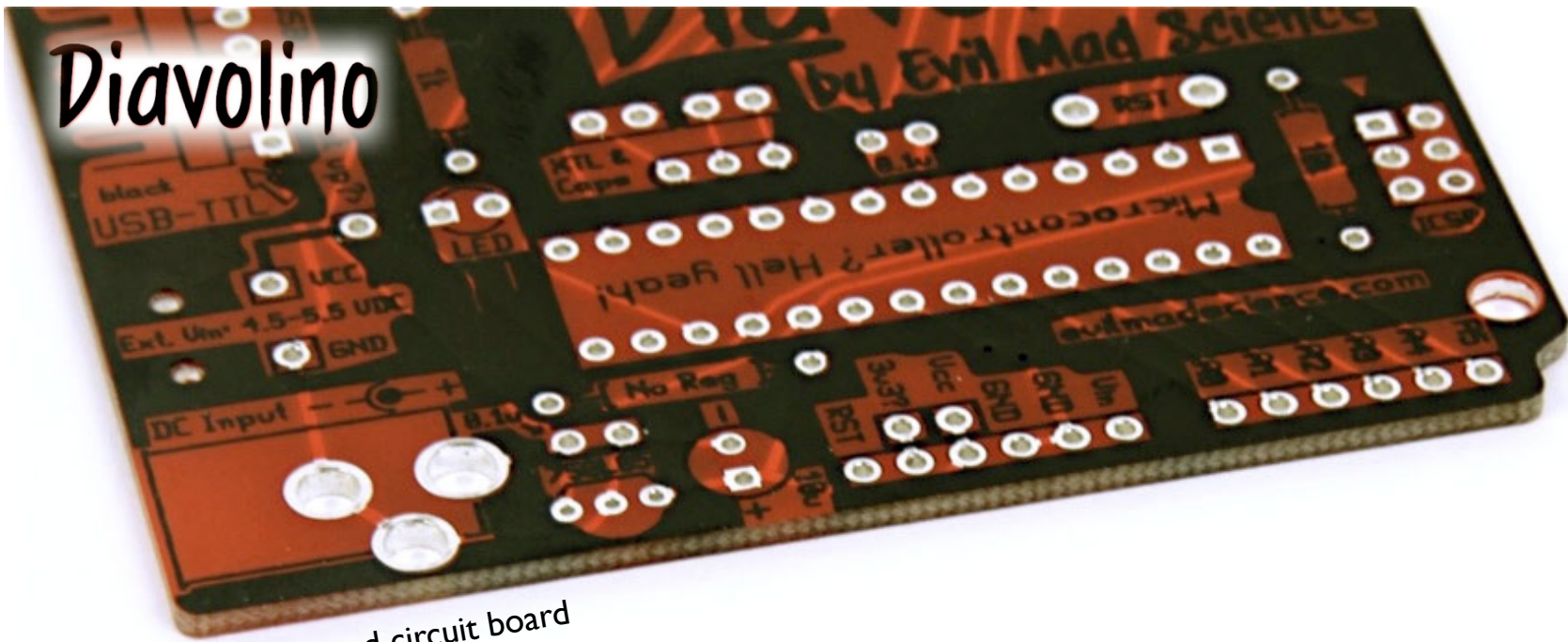

#1: Printed circuit board

#3: 1/4 W, 1 k resistor

(AKA, the big one)



#4: 1/6 W, 10 k resistor

(AKA, the little one)



You need to be able to tell apart these two resistors.
(The 1k resistor is the big one.)

Also note that the wire jumpers (#12) are similar, but only have a single black stripe.

Diavolino

Some hints on soldering

As the old Heathkit manuals say, "it is interesting to note" that the vast majority of problems reported with soldering kits turn out to be due to unreliable solder connections.

Before we go further, here's a quick refresher, with our suggested procedures for adding components to the circuit board. These procedures apply to most components in the kit.

Adding components to the circuit board

- (0). Pre-form the leads of components if needed.
(For example, like these resistors).
- (1). Insert each component into the circuit board, from the top, at its given location. Push it flush to the board
(Note that some components, like the chip and LED, need to be inserted with a particular orientation.)
- (2). If your component has flexible leads, *gently* bend the leads out, up to 45°, to hold it in place while you solder.
- (3). One at a time, from the back side, solder the leads of the component to the circuit board.

- Your tip *needs* to be *shiny* (tinned). If not, melt some fresh solder against it and *quickly* swipe clean on a wet sponge.
- Place the solder against the joint that you wish to connect.
- Touch the iron to the solder and joint for about one second. Count it out: "one thousand one."
- The solder should melt to the joint and leave a shiny wet-looking joint. If not, let it cool and try again.

- (4). If the component has long and/or flexible leads, clip off the extra length, close to the board. (But not so close that you're clipping the board itself.)

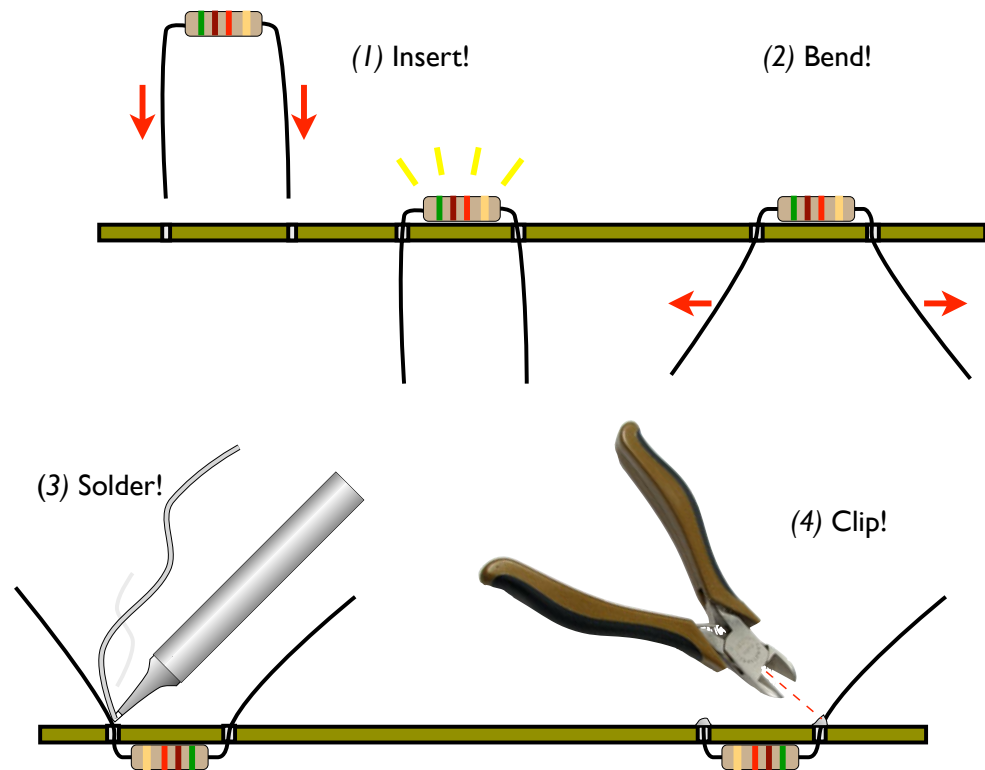

Diavolino

Let's start with the 1k resistor, #3.

First, bend down the leads like so.

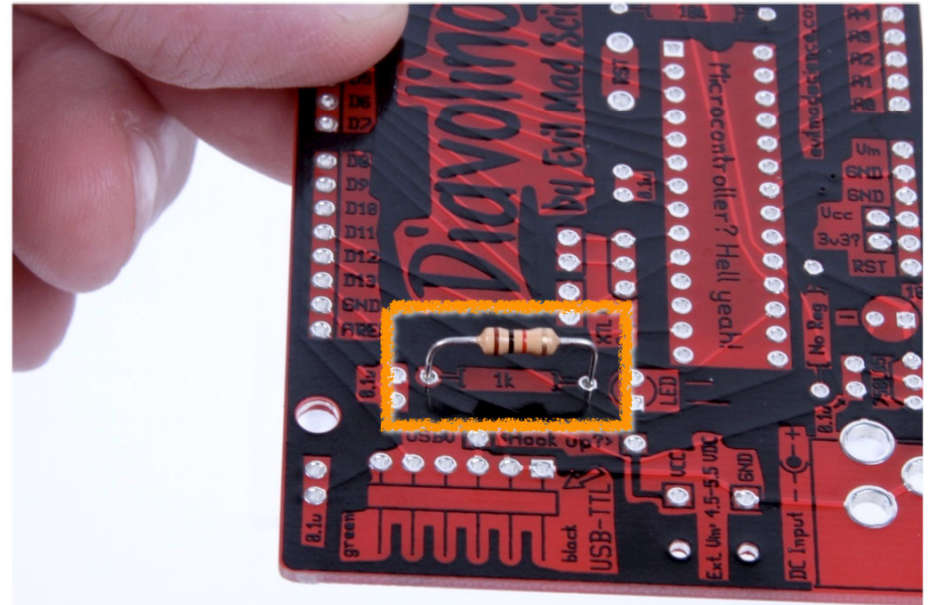
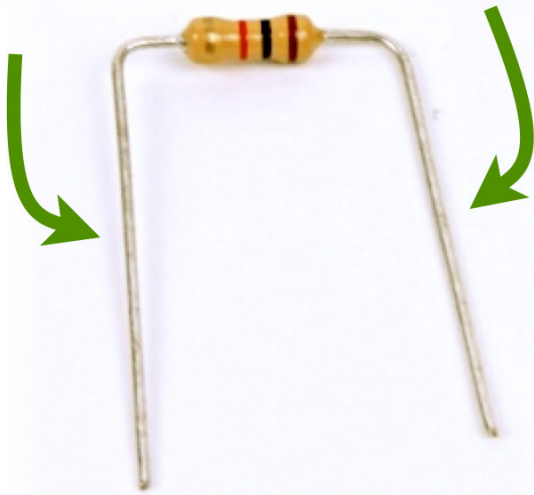

Insert the resistor in the "1k" location on the board.

Push down until flush...

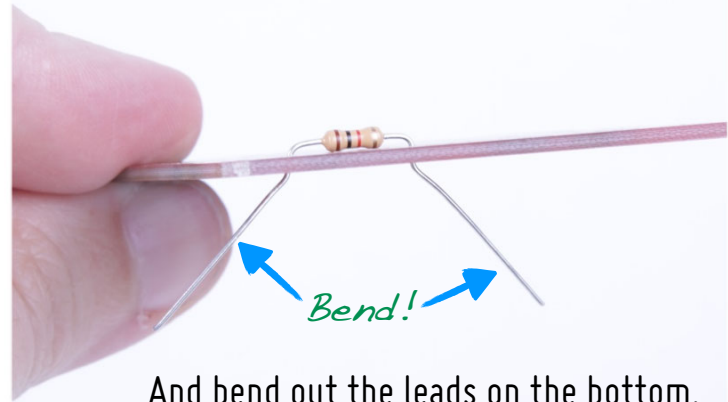
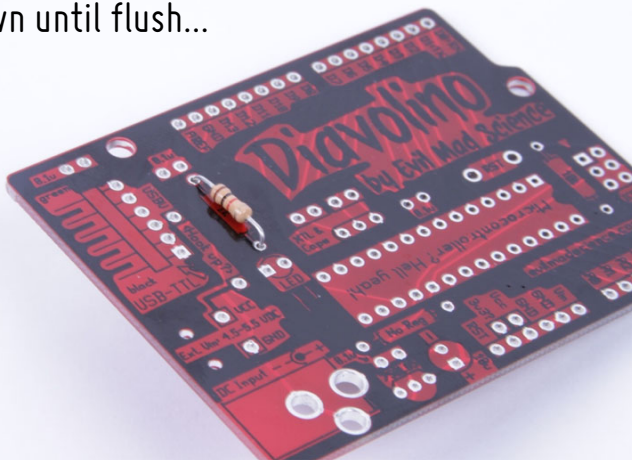

And bend out the leads on the bottom.

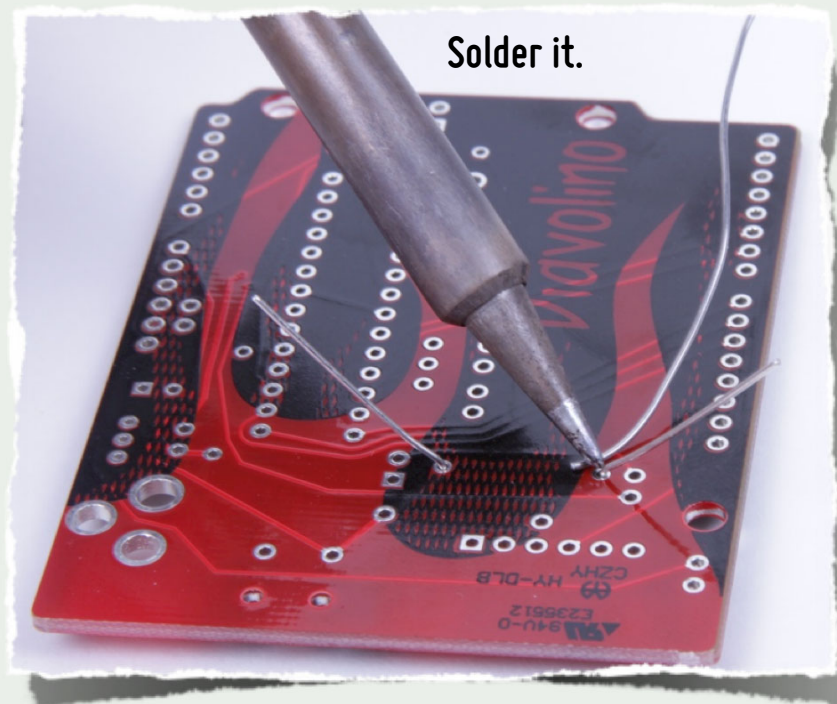

Solder it.

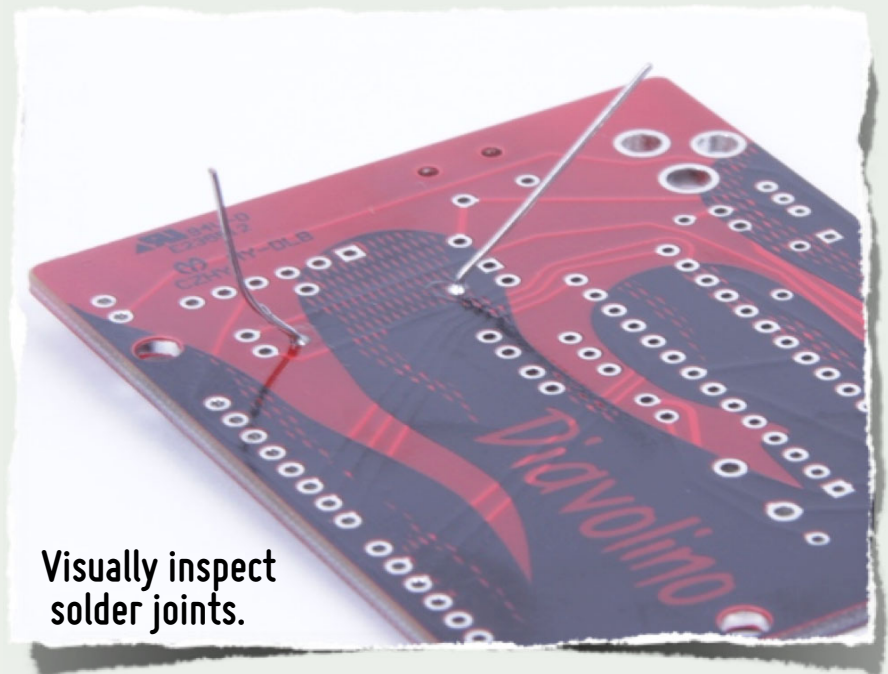

Visually inspect solder joints.

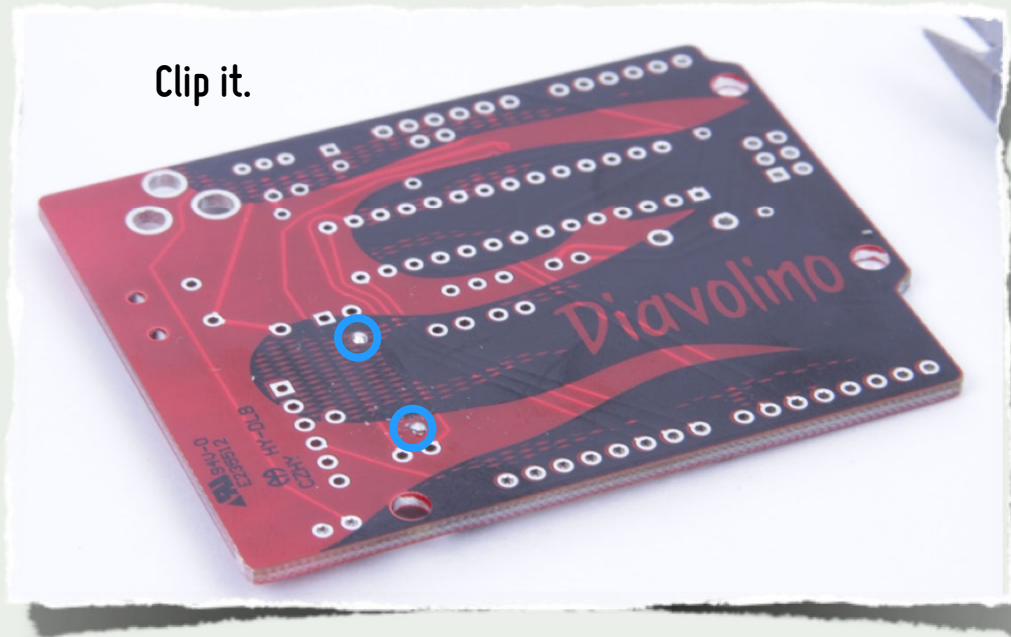

Clip it.



Correctly installed resistor.

Diavolino

Next: 10k resistor, #4.

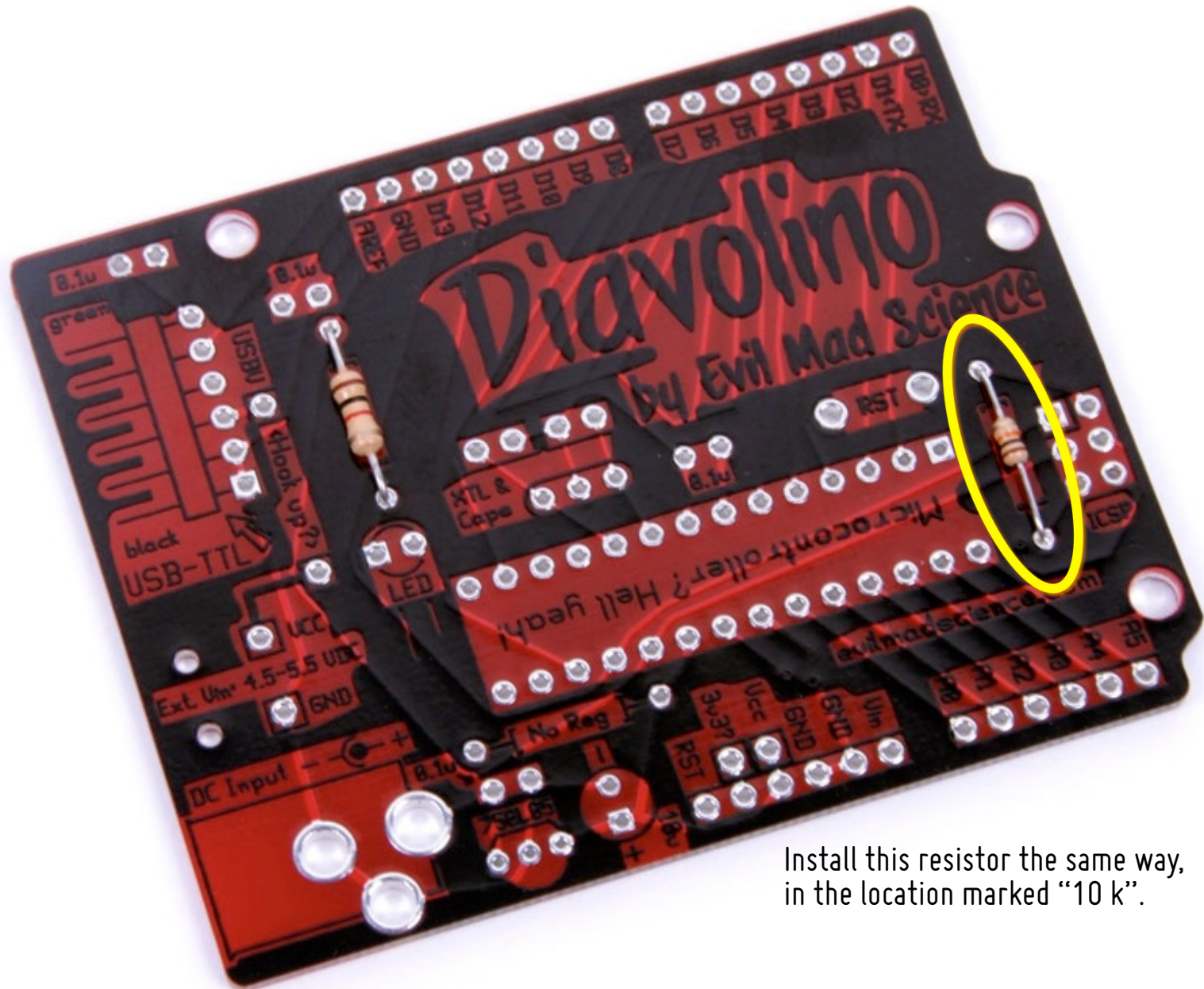

Install this resistor the same way, in the location marked "10 k".

Diavolino

18 pF caps, #5

The two 18 pF capacitors in the kits are marked by black stripes.

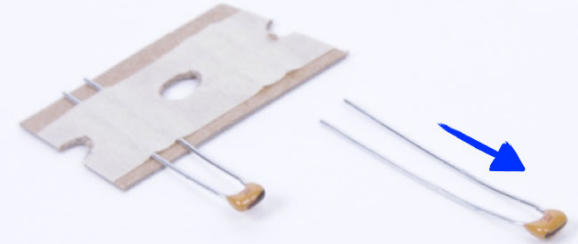
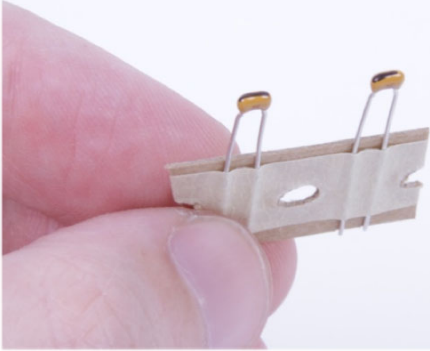

If they are taped together, pull them straight out of the tape to use them.

Add the two caps to the board here:

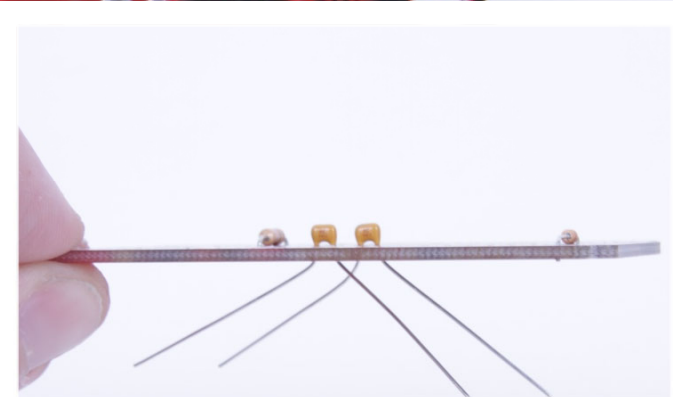
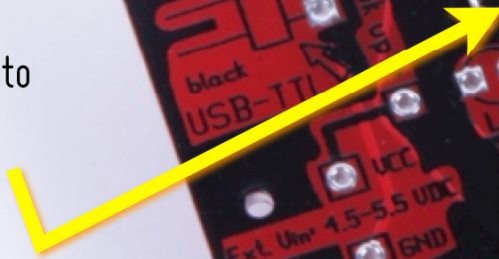

Bend the leads out below the board, then solder and clip the leads.

Diavolino

0.1 uF caps, #6

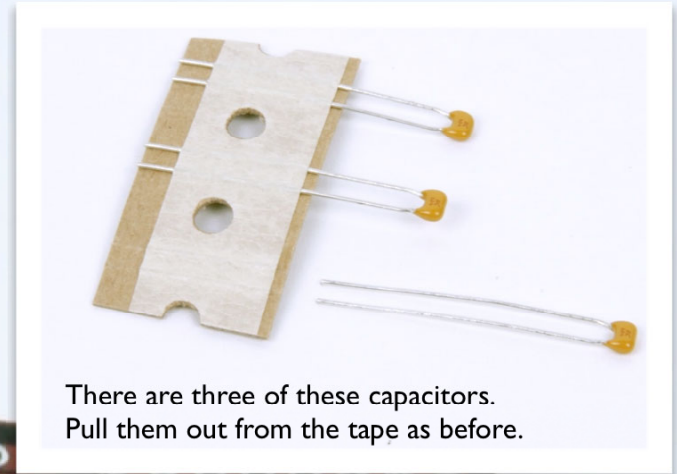

There are three of these capacitors.
Pull them out from the tape as before.

Add the three caps in the locations shown.
Bend out, solder, and trim the leads as usual.

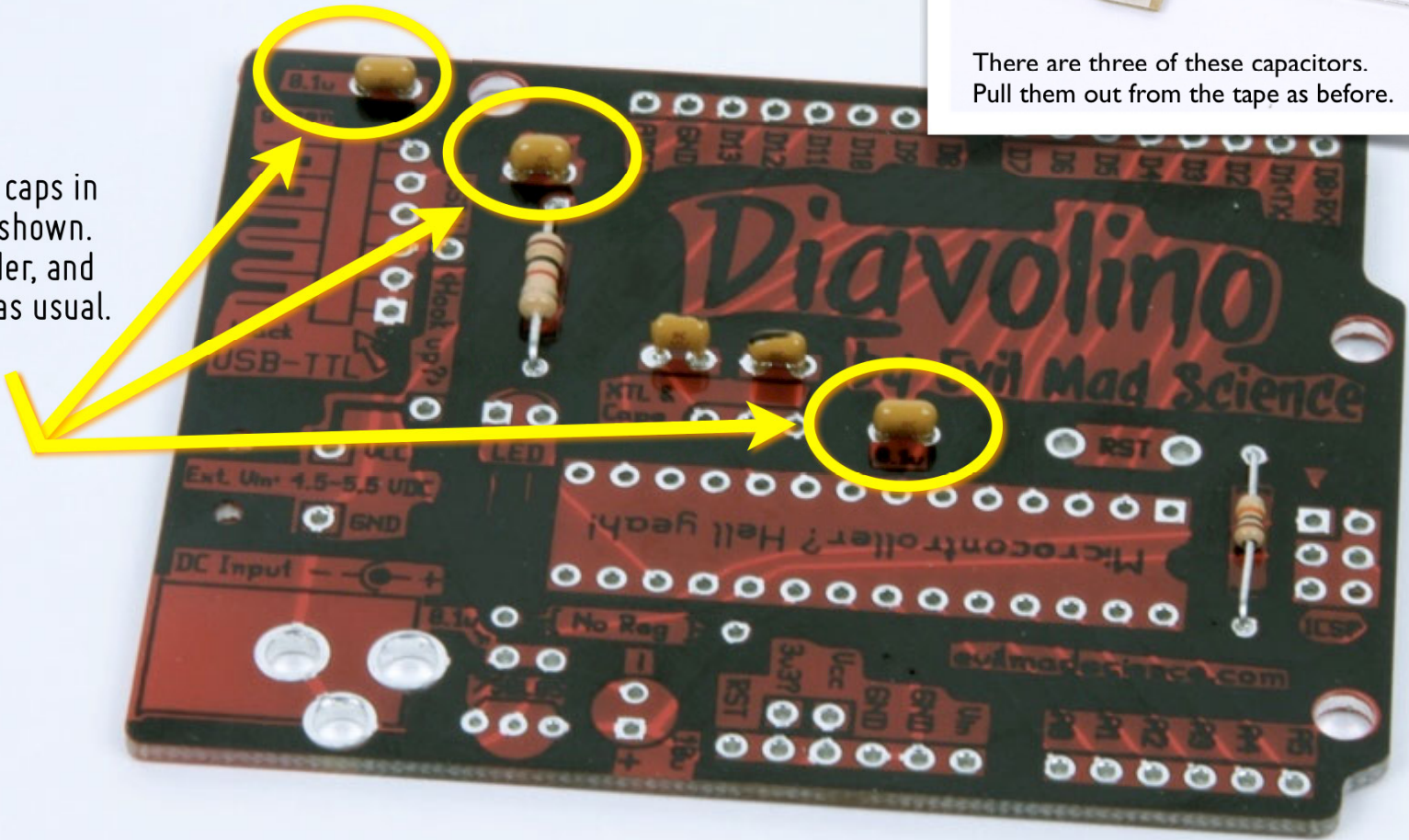

Diavolino

Tactile button switch, #7

Insert the switch where shown.

It may *snap* into place.

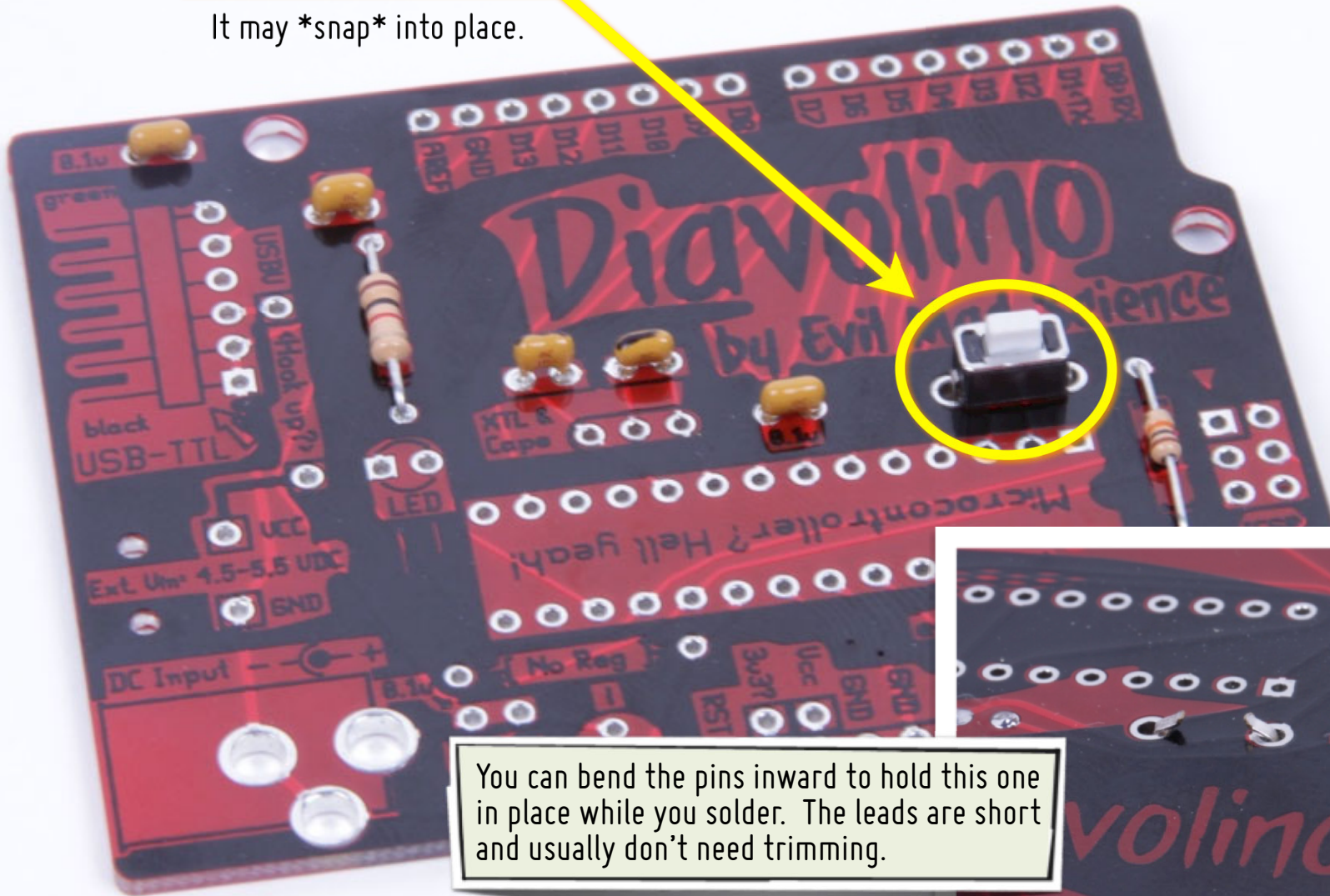

You can bend the pins inward to hold this one in place while you solder. The leads are short and usually don't need trimming.



Diavolino

LED, #8



3 mm red-diffused LED.
Note the short and long leads:
Orientation matters!

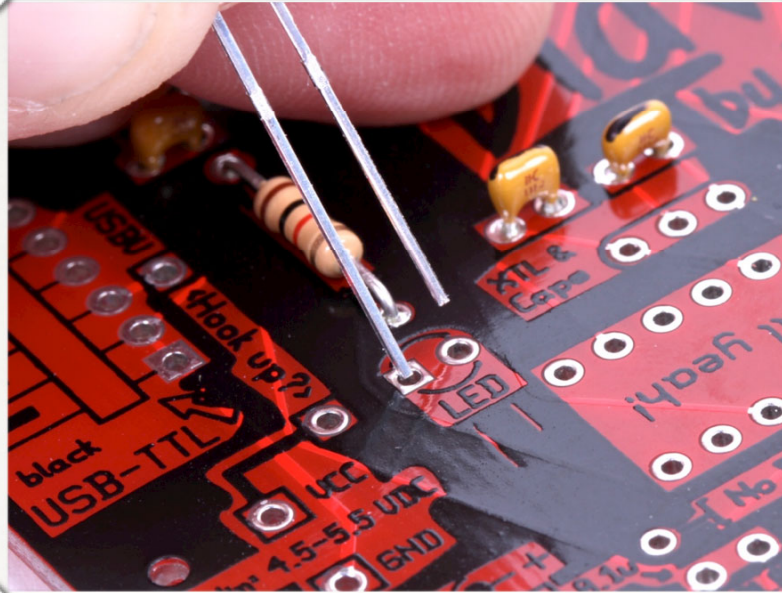

Put the long lead in the square hole.

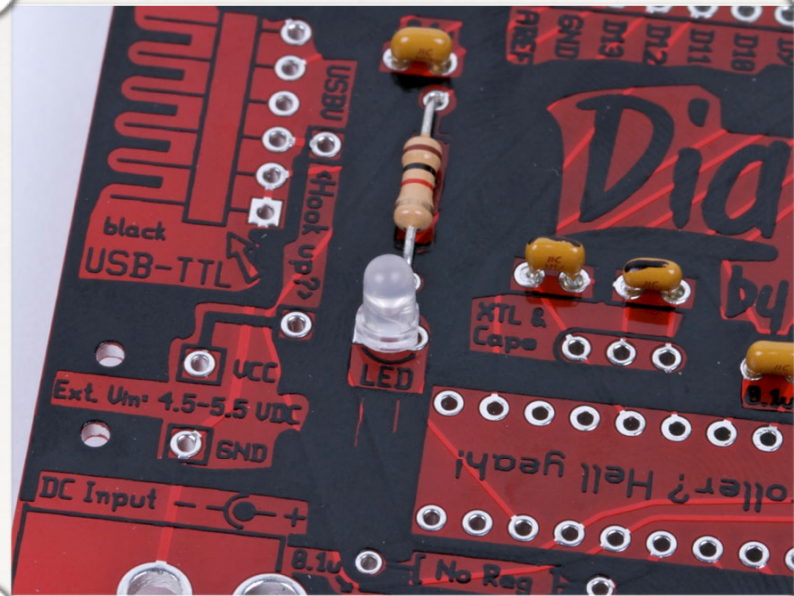

Then push flush, solder & trim as usual.

Diavolino

16 MHz Quartz crystal oscillator, #9



A shiny little can with two leads

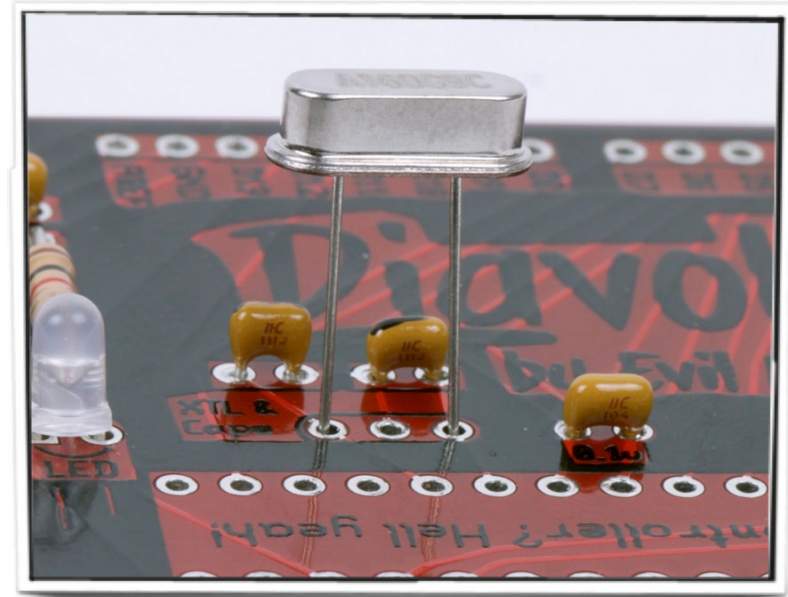

Orientation does not matter, but the two pins go in the **outer two holes** of the three available.

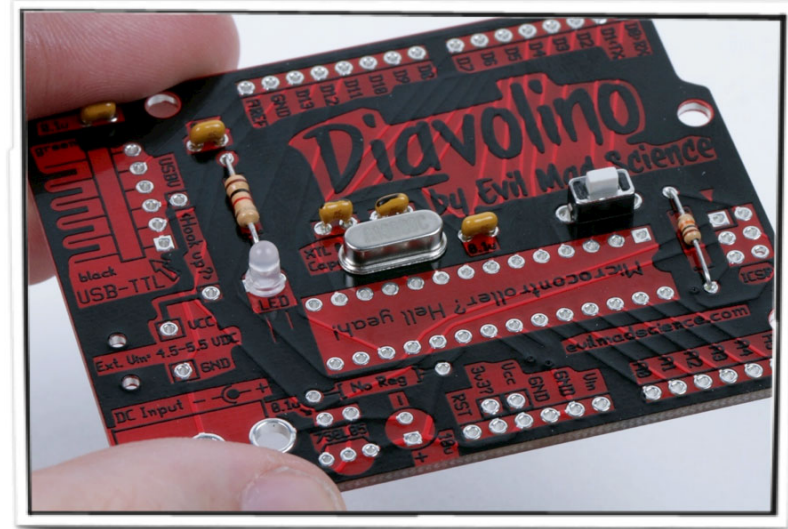

Then push flush, solder & trim as usual.

Diavolino

Header #10

This is the connector for the USB-TTL cable.

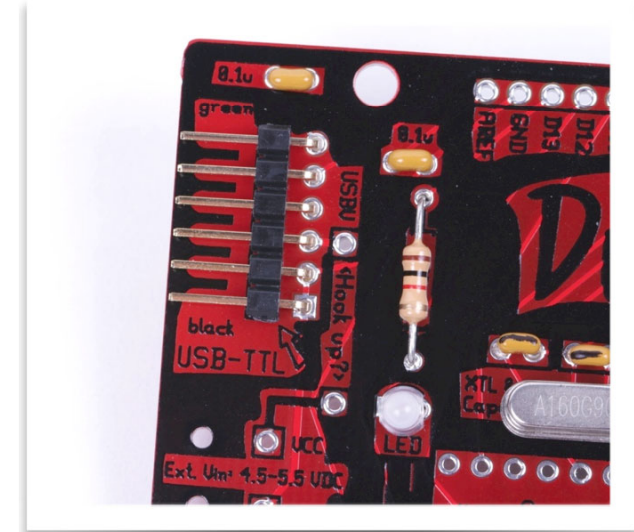
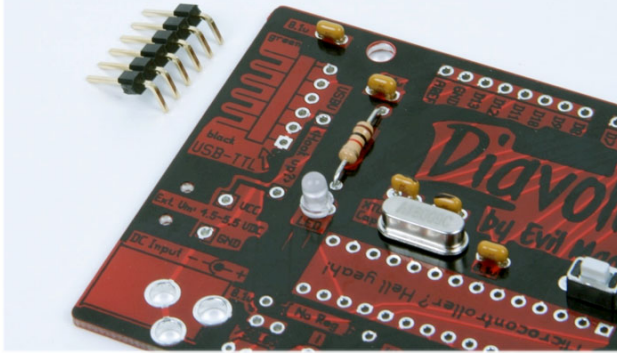

Test-fit it in place so that you see where it goes.

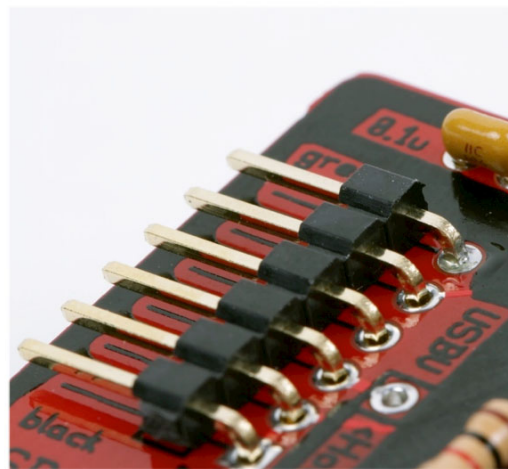
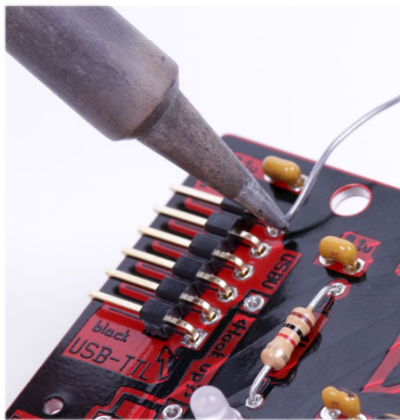

These pins don't bend. So, to hold it in place when you solder, first solder one of the pins from the top to tack it in place.

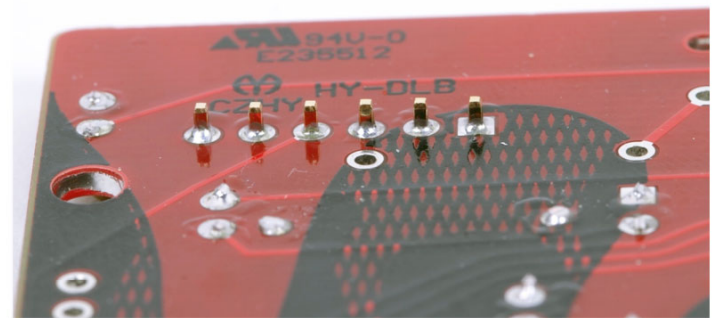

Solder the other five pins from the back. You shouldn't need to trim them after soldering.

Diavolino

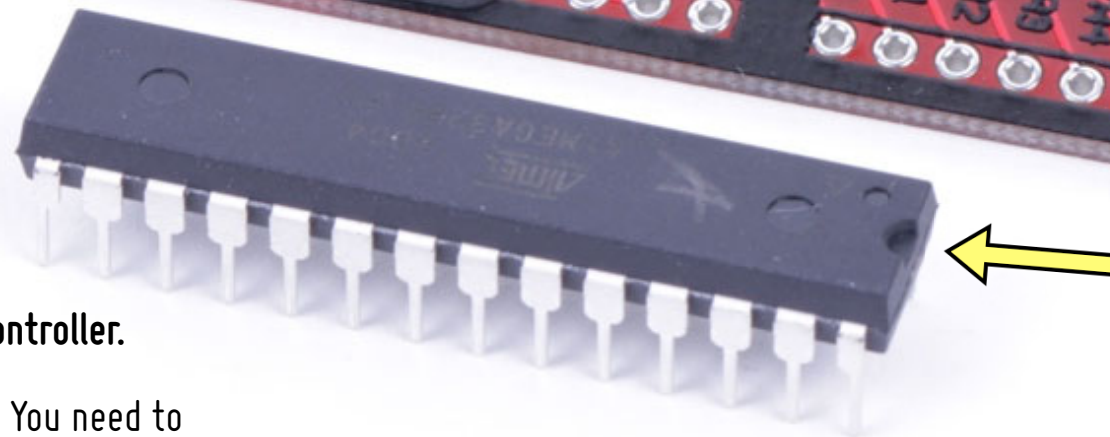
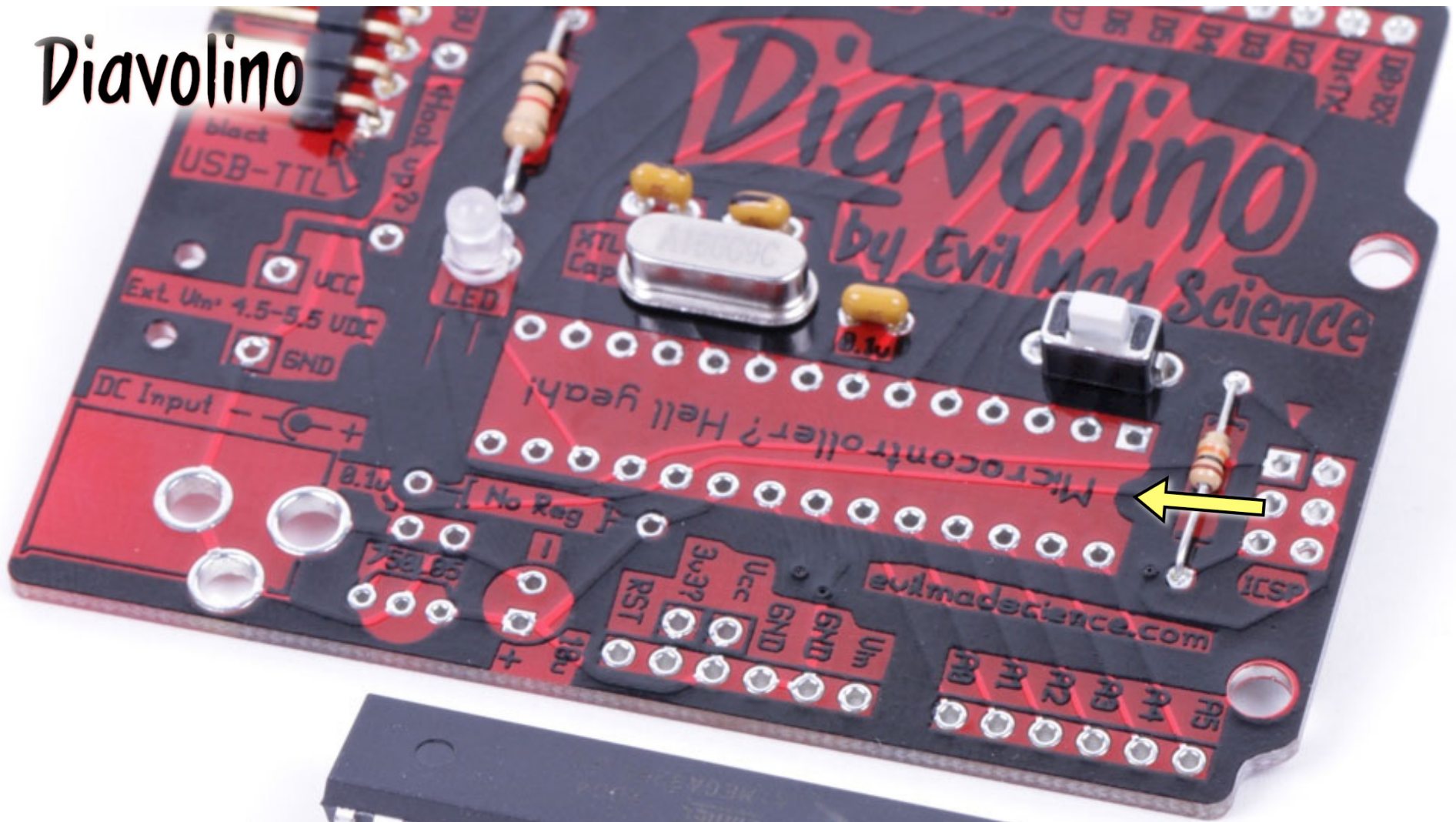

Time for the microcontroller.

Orientation matters. You need to orient it with the half moon shape on one end of the chip matching that on the circuit board.

Diavolino



Carefully insert the chip.

Again, double-check the orientation.

The chip should easily slip into the board. If necessary, bend the pins of the chip to straight up and down before inserting the chip. Do not bend them by hand; bend all pins on one side at a time by pushing them against a hard flat surface.

From end of chip:

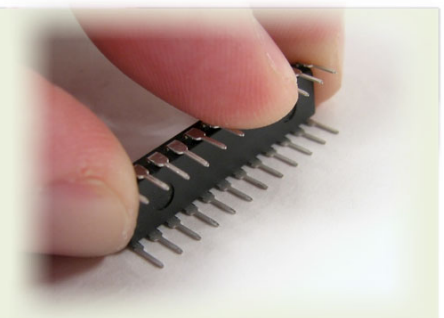
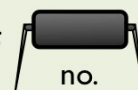

Diavolino

Flip the board over and solder the chip in place—
all 28 pins.

Tip: Gently bend over the corner pins to hold the
chip in place while you solder.

HY-DLB

Diavolino

This concludes the essential portion of the build.

Most users will also configure some of the option jumpers and/or add power sources. We'll get to these next.

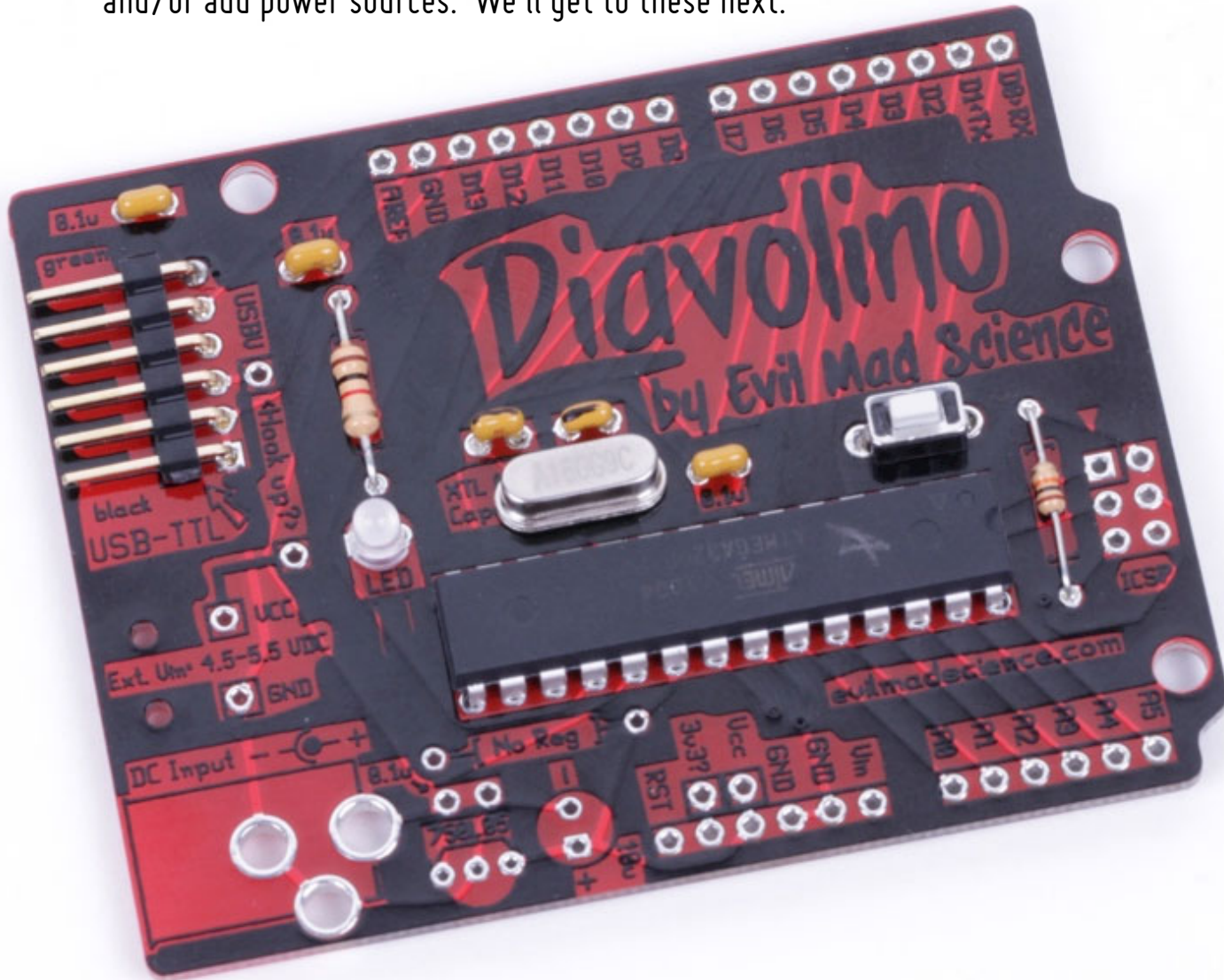

Diavolino

Configuration options:

- * USBV jumper: Adding this wire jumper connects the USB 5V line to Vcc, providing power from USB to your circuit. Add this jumper if you want to power your Diavolino from a 5V USB-TTL cable.
- * Regulator jumper: This jumper connects the dc input (“Vin”) directly to Vcc. Use this jumper only if you are using a plug-in 5 V dc power supply, where no regulator is needed. If you are using a regulator, remove this jumper.
- * 3.3V jumper: The 3.3 V pin is normally unconnected. If you want to hook it to Vcc, you can add a wire jumper here.

Important tips:

- The AVR microcontroller requires 4.5 – 5.5 V power (Vcc) when operating at 16 MHz.
- Be careful to only apply power from one source at a time: USB-TTL, dc adapter, or battery.
- For programming, you’ll need an FTDI TTL-232R cable or an equivalent USB-TTL interface.
- Within the Arduino IDE, please select board type (from the menu) as Duemilanove w/‘328.

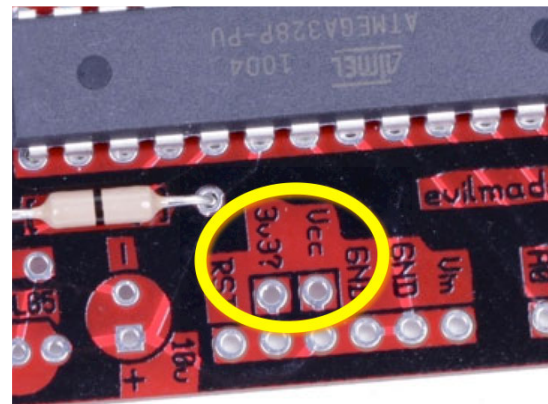

Diavolino

How to add a battery box

The chip requires 4.5 – 5.5 V DC when operating at 16 MHz. You can get 4.5 V from three Alkaline AA or AAA cells.

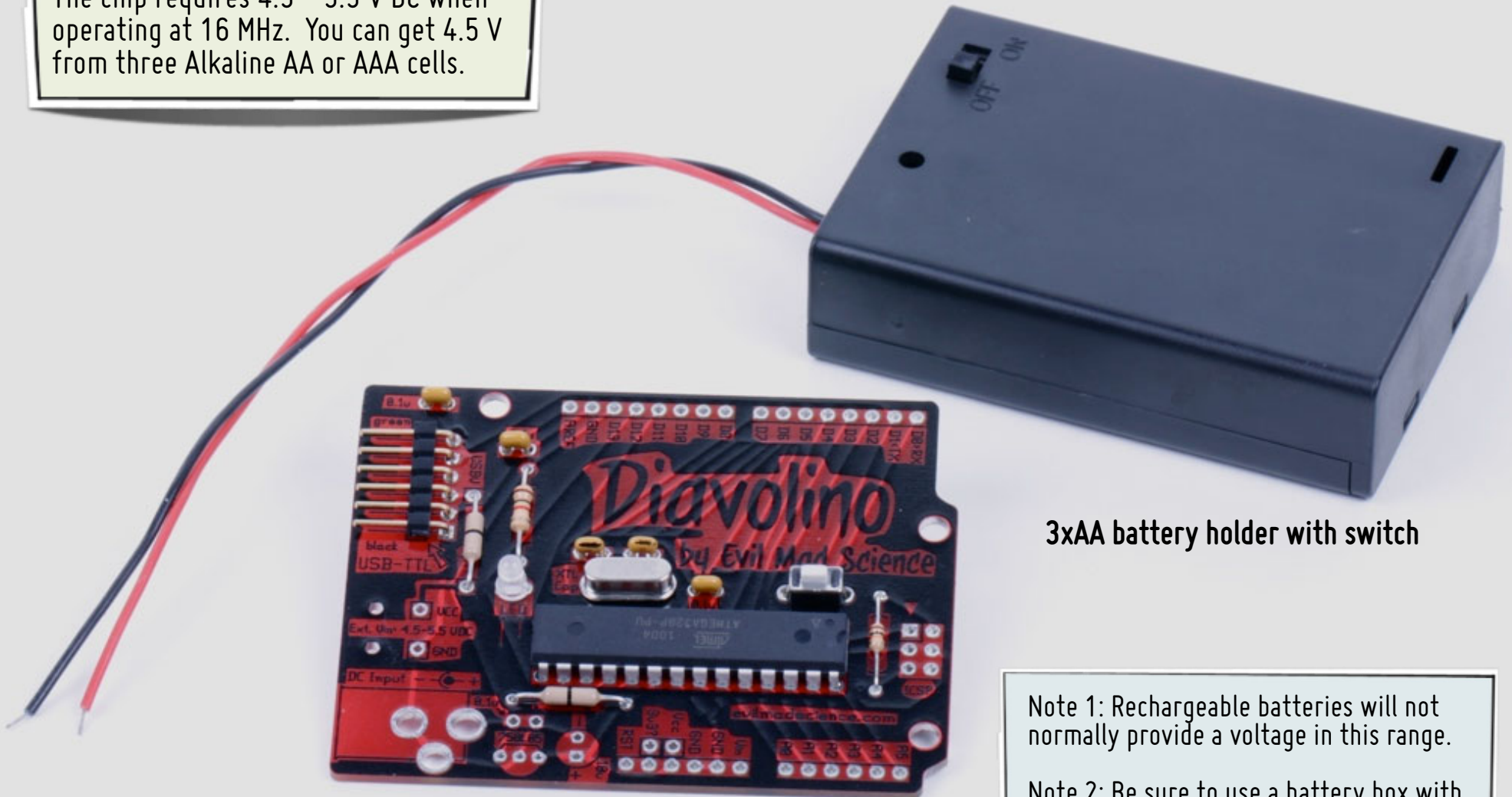

3xAA battery holder with switch

Note 1: Rechargeable batteries will not normally provide a voltage in this range.

Note 2: Be sure to use a battery box with a power switch, because you can only provide power from one source at a time.

Diavolino

How to add a battery box (continued)

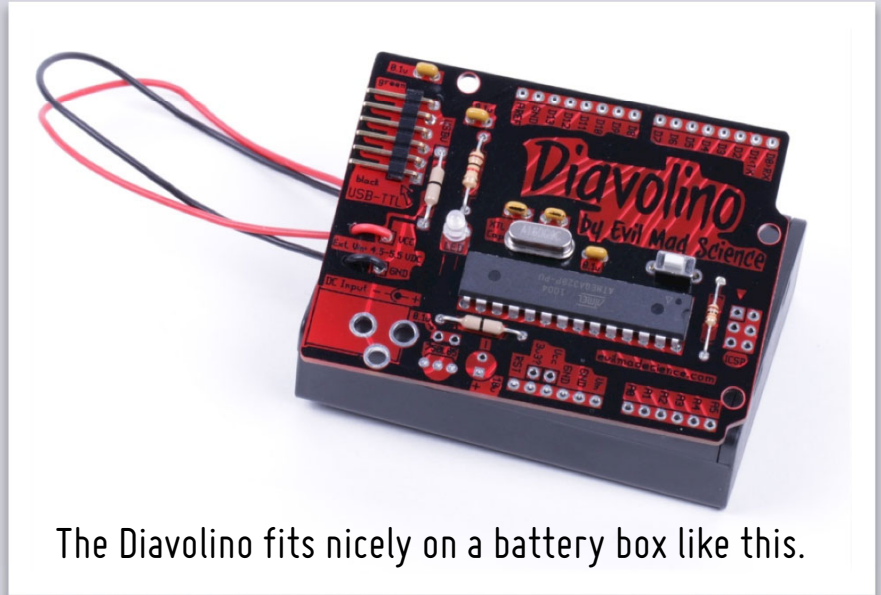

The Diavolino fits nicely on a battery box like this.

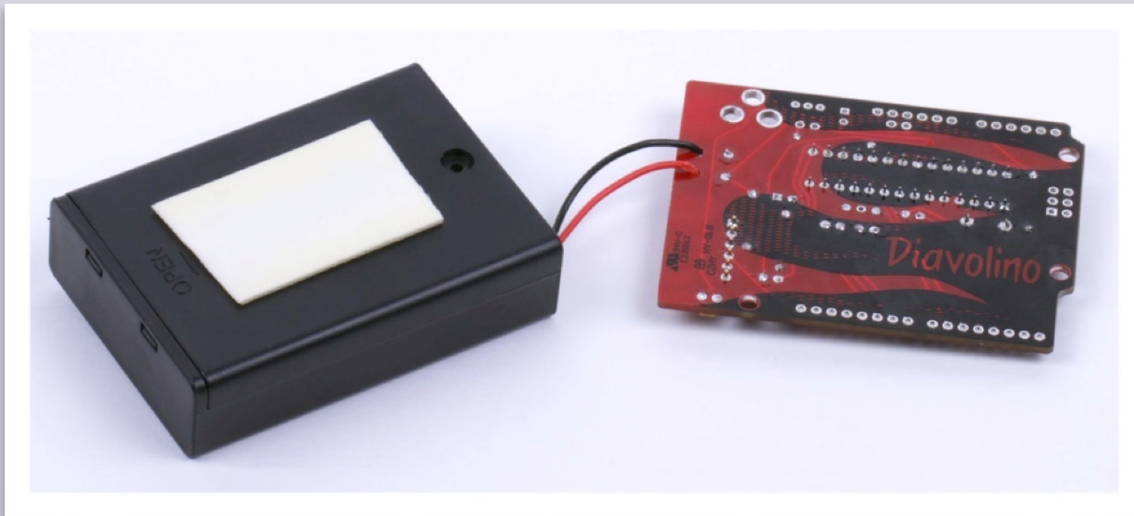

To make it even neater, you can trim the wire leads to a couple of inches (and strip the ends) to reduce the amount of excess wire.



You can also mount it directly to the battery box with a strip of double-sided foam tape.

Diavolino

How to add a battery box (continued)

Whether or not you trim the leads, here's the procedure:

First, bring the wire leads up through the strain-relief holes at the edge of the board as shown.

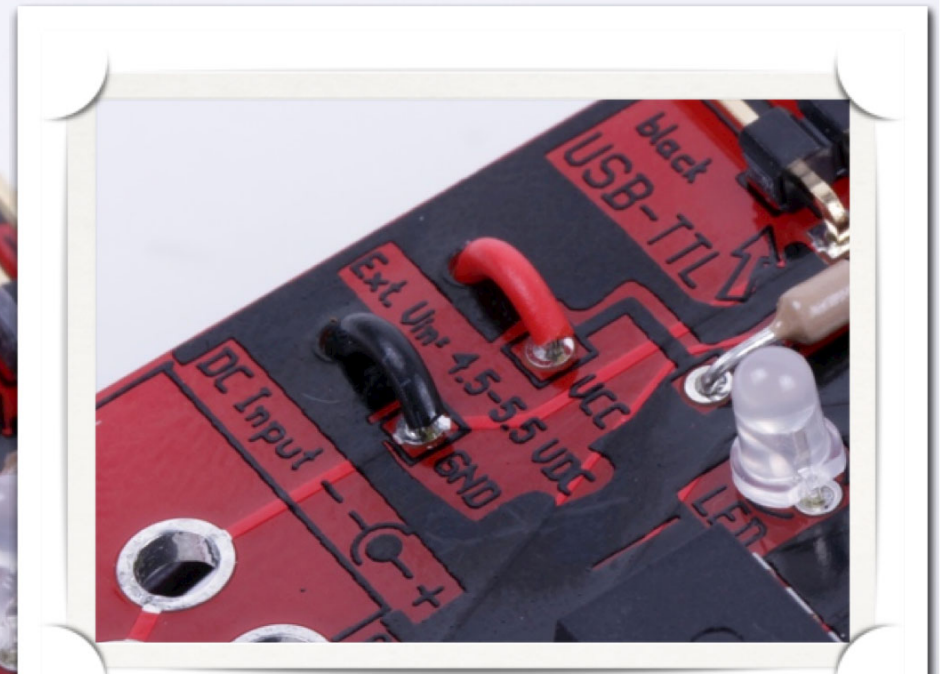
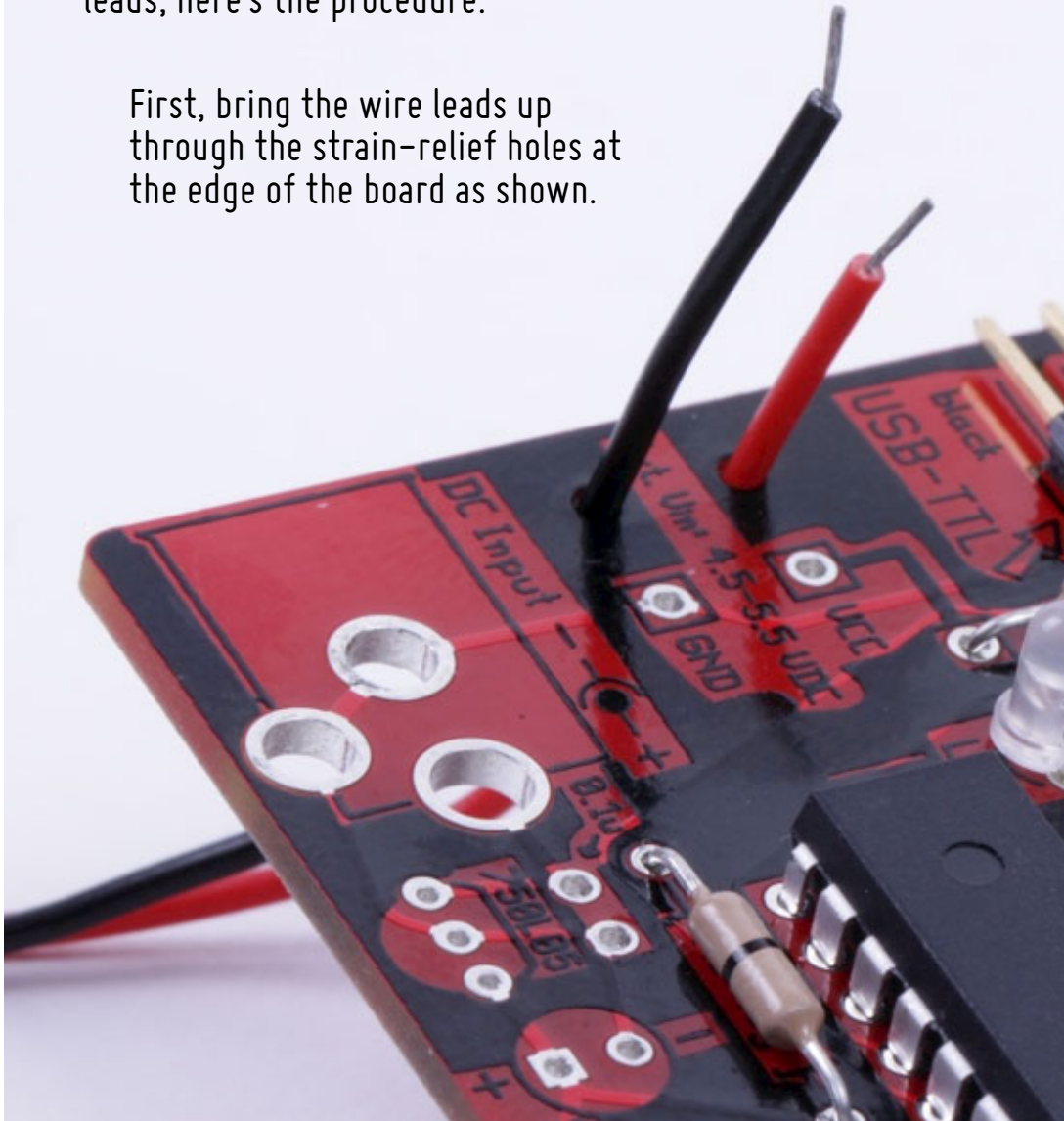

Then, solder the red wire in location VCC and the black wire in location GND.

Pull any excess wire back through the strain-relief holes to take out the slack.

Diavolino

Adding socket strips

These socket strips are an optional extra for connecting to Arduino-style “shield” boards. Insert them where shown and solder them in place, flush to the board.

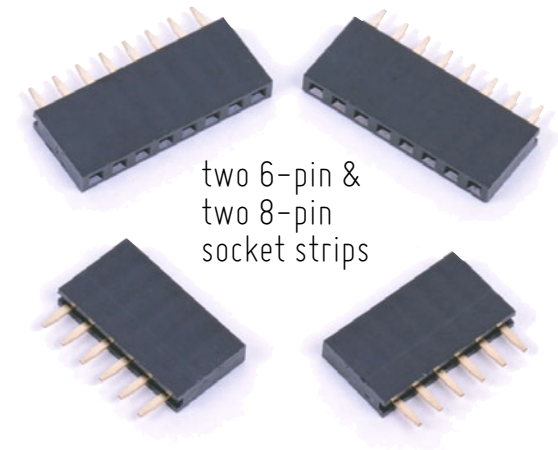
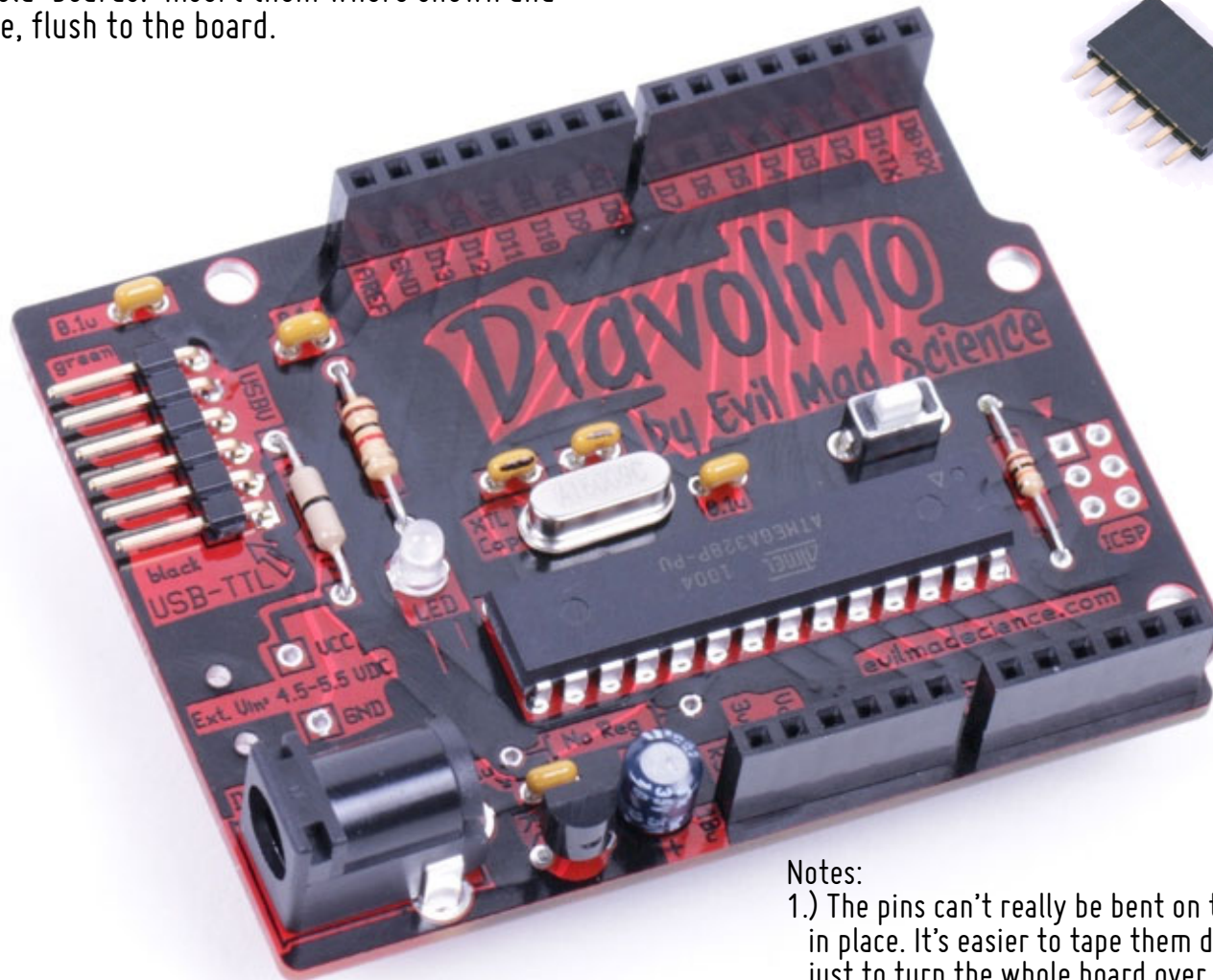

two 6-pin &
two 8-pin
socket strips

Notes:

- 1.) The pins can't really be bent on the back side to hold them in place. It's easier to tape them down with masking tape or just to turn the whole board over, resting on them.
- 2.) It's best to solder one pin on each first, to make sure that they're straight and flush, before soldering the rest.
- 3.) The pins are short enough that they don't normally need trimming.

Diavolino

Providing power from USB

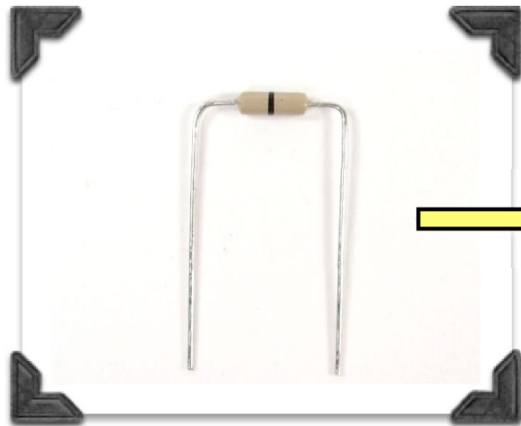

One of the zerohm jumpers.
(It has one black stripe.)

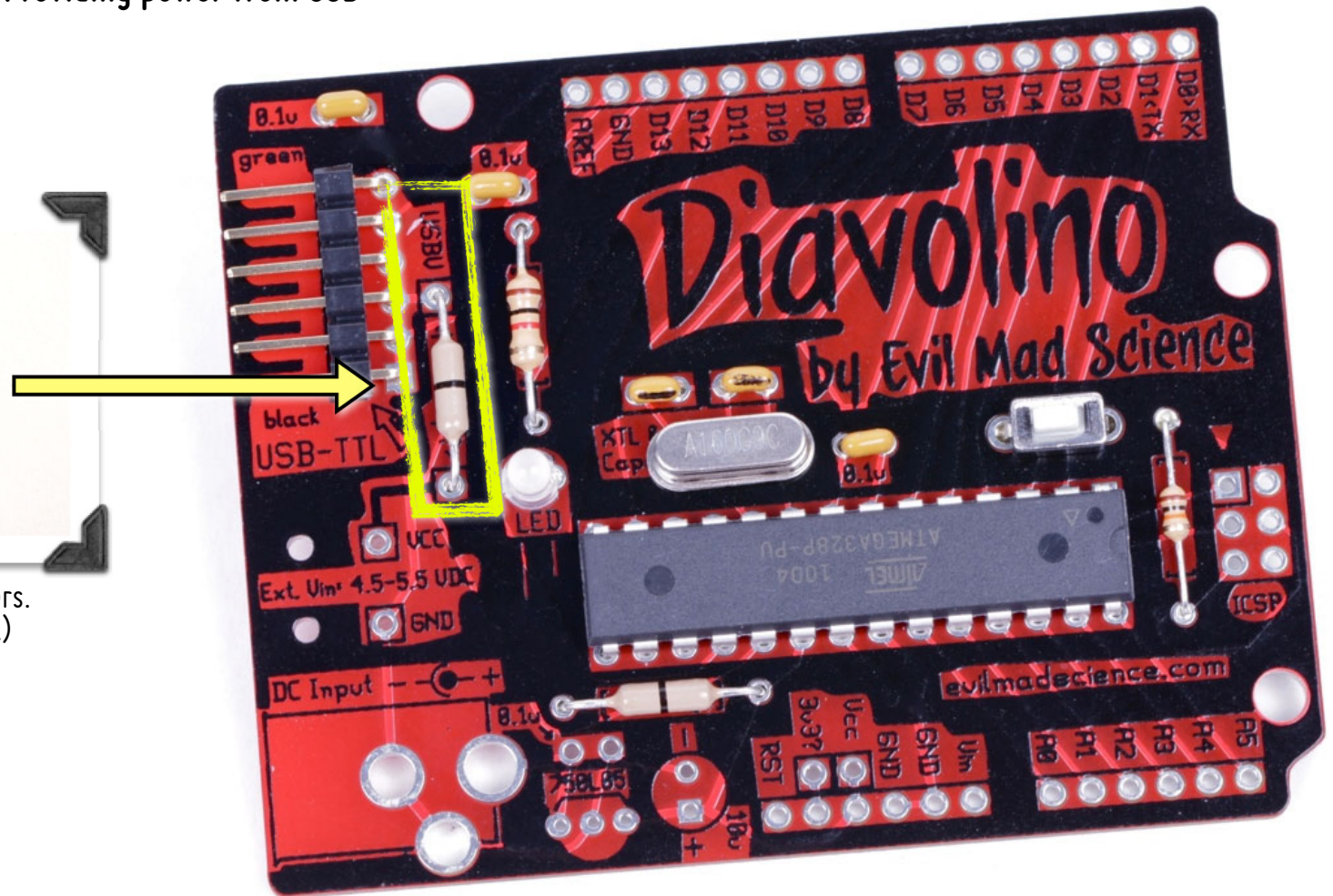

If you have a USB-TTL interface that provides 5 V, such as the FTDI TTL-232R-5V, you can hook that up to provide 5V power to your board.

To make this connection, add a zerohm jumper to the “USBV” location on the circuit board.

Note 1: Most computer USB interfaces are limited to sourcing 500 mA.

Note 2: If you use this option, be sure to disconnect any other power sources when you plug in your USB-TTL cable, because you can only provide power from one source at a time.

Diavolino

Connecting USB-TTL cable

The board is labeled with proper colors for connecting the FTDI USB-TTL cable. Green towards the top, black towards the bottom.

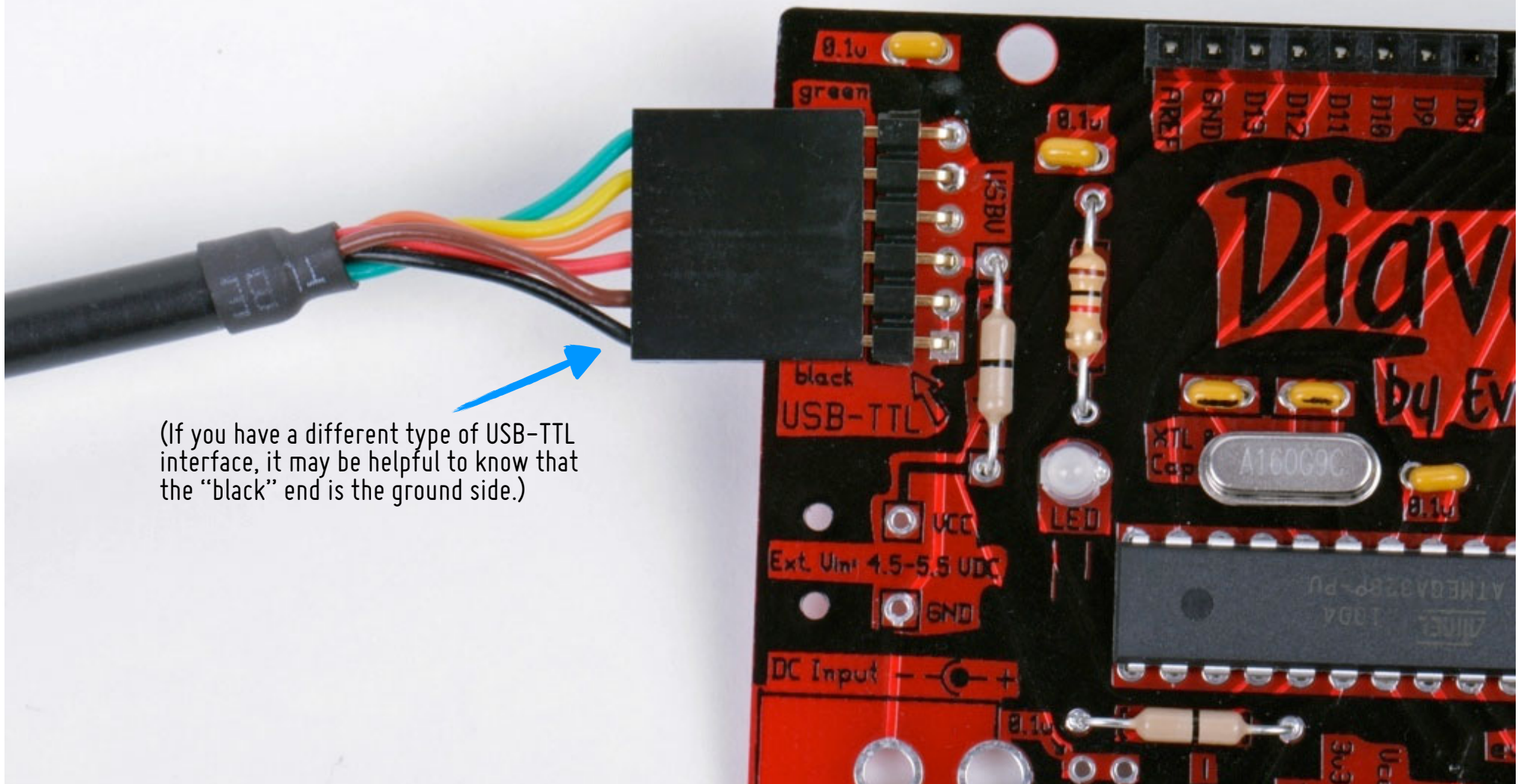

(If you have a different type of USB-TTL interface, it may be helpful to know that the “black” end is the ground side.)

Diavolino

Using a 5V DC power adapter

This is a regulated 5 V DC power adapter (center positive). Since it directly gives you 5 V DC, you do not need (and cannot use) an external 5 V regulator with it.



Jack

Reg. bypass jumper
("No Reg")

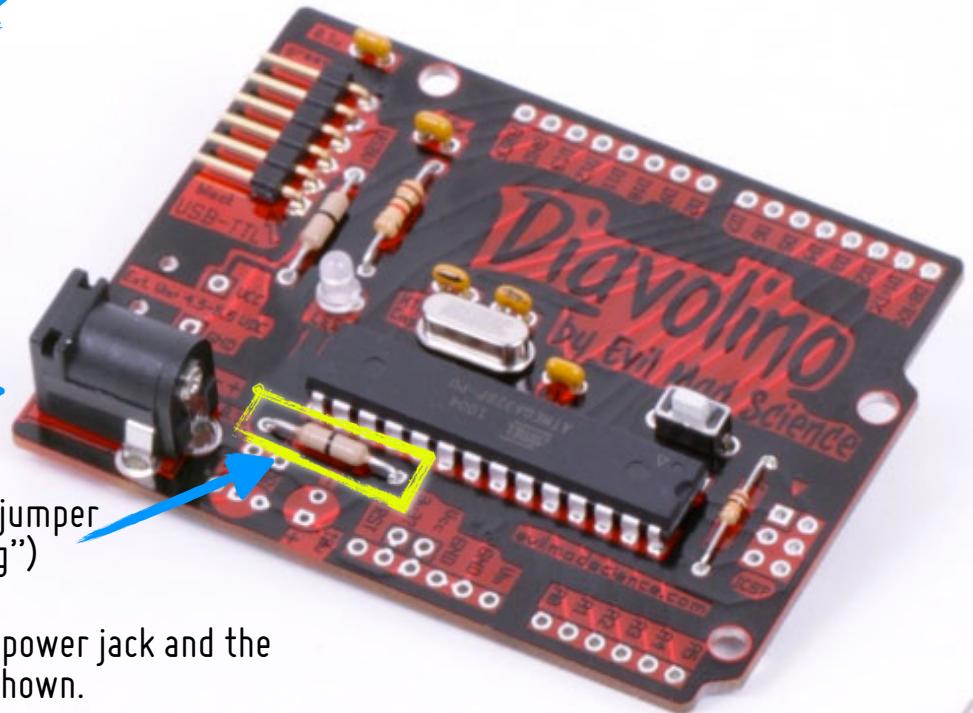

To use this power adapter, just add the power jack and the "regulator bypass" zerohm jumper as shown.

Note: If you use a power adapter, be sure to disconnect any other power sources when you plug in your adapter, because you can only provide power from one source at a time.

Diavolino

Using a > 6V DC power adapter

This is a 9 V DC power adapter (center positive). Since it does not directly give you 5 V DC, you will need an 5 V regulator to use it.



5V regulator

Besides the jack, you will also have to add the 5V regulator. DO NOT also use the regulator bypass jumper— that would short-circuit the regulator.

Diavolino

Using a > 6V DC power adapter (continued)

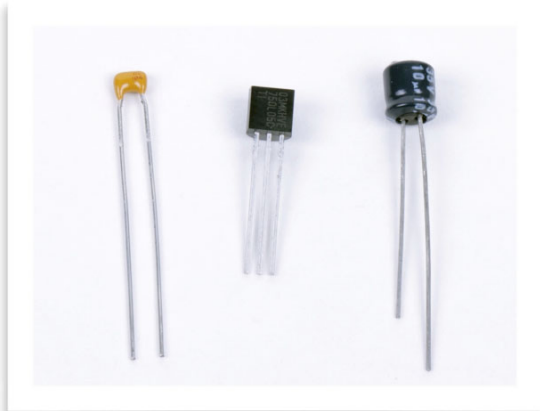

There are three parts to the regulator:
A 0.1 uF ceramic capacitor (left),
The regulator itself (middle), and
a 10 uF electrolytic cap (right).

Our normal regulator is type 750L05, a
150 mA regulator. You can also use a
type L4931CZ50-AP 300 mA regulator.



Orientation of the regulator matters:
match the flat side to the drawing on
the circuit board.

**Orientation of the 10 uF capacitor
matters:** Orient the side with the big
“-” stripe towards the “-” on the
circuit board.



Note: Again, if you use a power adapter, be sure to disconnect
any other power sources when you plug in your adapter,
because you can only provide power from one source at a time.

Diavolino Schematic Diagram

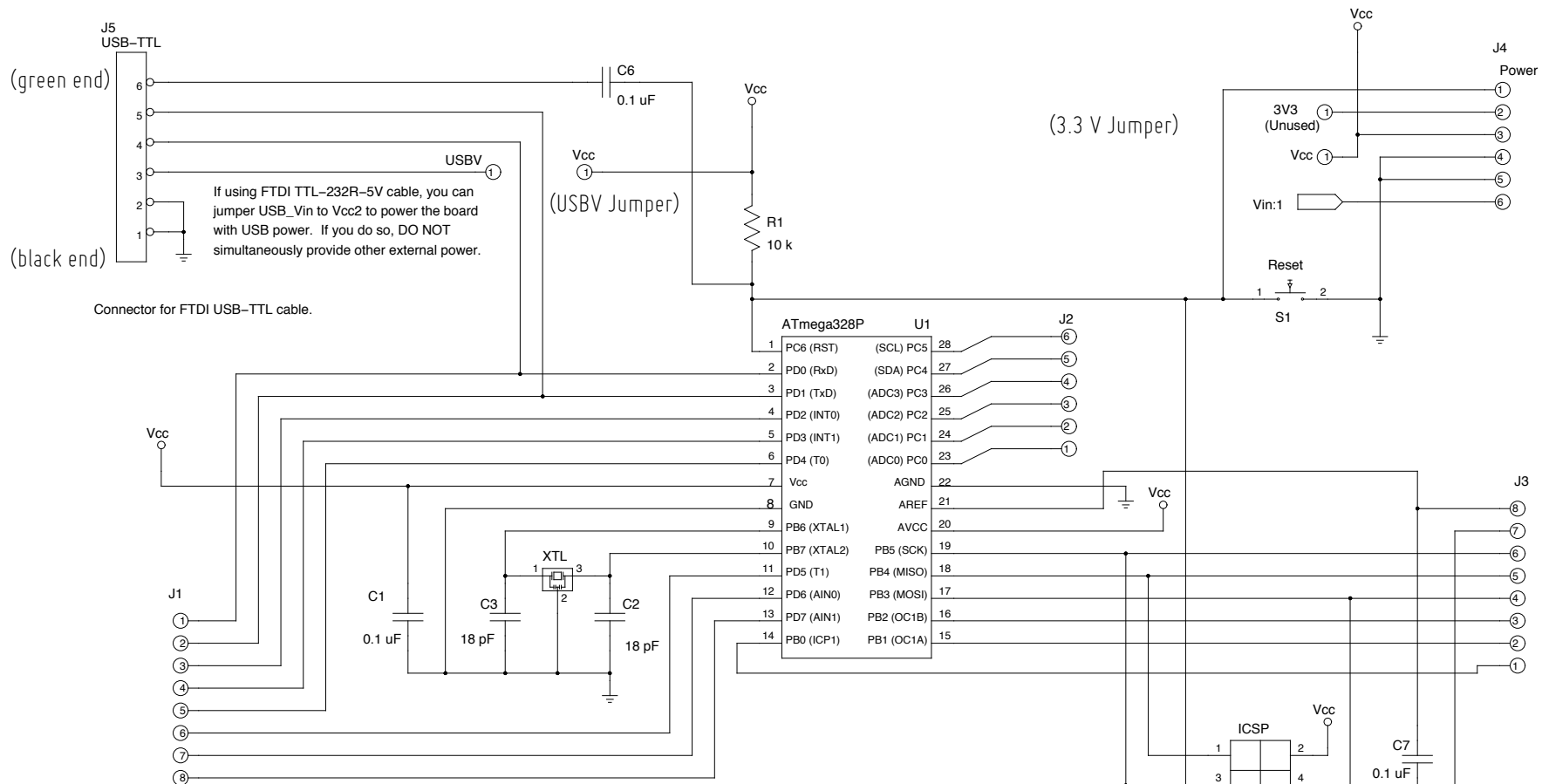

If using FTDI TTL-232R-5V cable, you can jumper USB_Vin to Vcc2 to power the board with USB power. If you do so, DO NOT simultaneously provide other external power.

Connector for FTDI USB-TTL cable.

Use Jumper or regulator.

With Jumper, acceptable inputs include:
5 V DC regulated adapter,
4.5 V battery input

With regulator, acceptable inputs
are DC power supplies, 5.5-12 V.

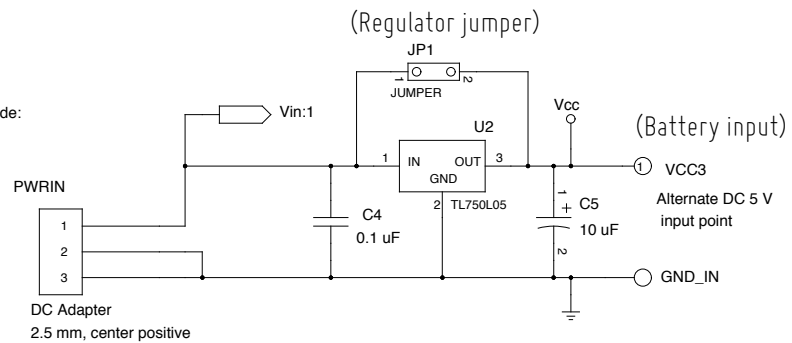

Copyright 2010, Windell H. Oskay/Evil Mad Science LLC
Distributed under the TAPR Open Hardware License
www.tapr.org/OHL

Freeduino FTW, BTW.

An Open-Source Design by
Evil Mad Scientist Laboratories
www.evilmadscientist.com

Fabricated for
Evil Mad Science LLC
<http://evilmadscience.com/>

TITLE Diavolino	
FILE: diavolino.sch	REVISION: A
PAGE 1 OF 1	DRAWN BY: Windell H. Oskay